Pilot devices, 22 mm

Compact range

Ordering details

91	Non-illuminated flush pushbuttons
93	Non-illuminated extended pushbuttons
95	Illuminated flush pushbuttons
97	Illuminated extended pushbuttons
99	Non-illuminated mushroom pushbuttons
100	Non-illuminated emergency stop pushbuttons
101	Non-illuminated machine stop pushbuttons
102	Heavy duty pushbuttons
103	Pilot lights
106	LED bulbs for CL-100 pilot lights
107	Non-illuminated selector switches
109	Buzzers

110 Accessories

112 Technical data

118 Drilling plan

Compact range

The compact range is the most efficient solution reducing both installation time and cost thanks to the all-in-one design. It is perfect for tough environment thanks to the market leading level of dust and water resistance.

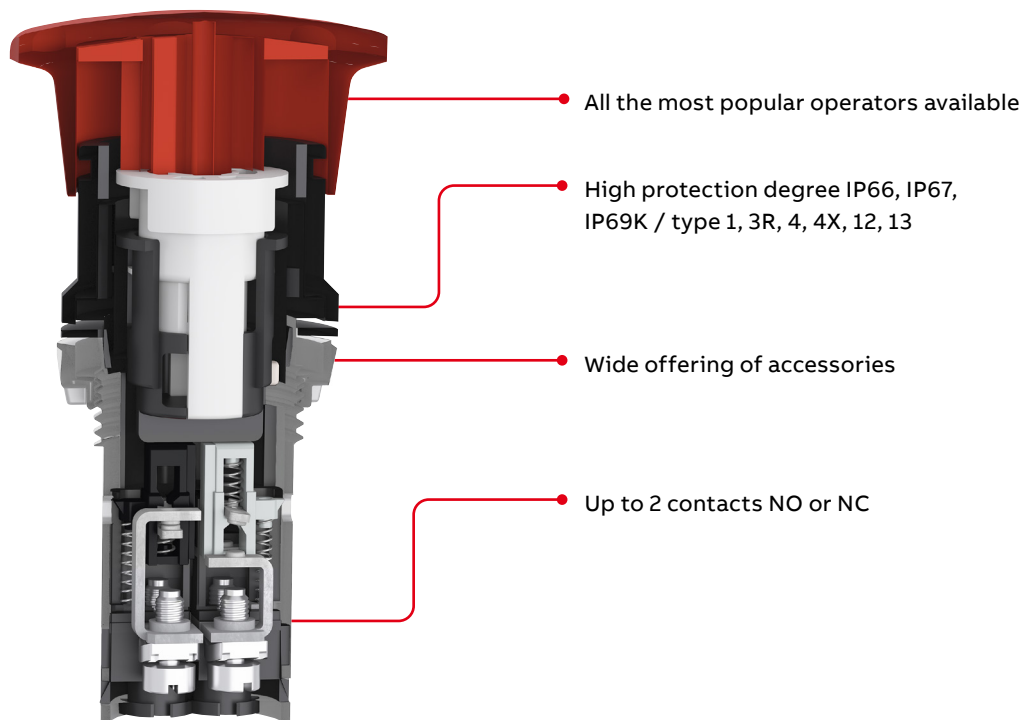

Compact range

Non-illuminated flush pushbuttons - Momentary



Operator	Bezel	Contacts	Type	Order code	Pkg qty	Weight (1 pce)		
						kg		
● Red	Black plastic	10	CP1-10R-10	1SFA619100R1011	10	0.018		
		01	CP1-10R-01	1SFA619100R1041	10	0.018		
		11	CP1-10R-11	1SFA619100R1071	10	0.022		
		20	CP1-10R-20	1SFA619100R1021	10	0.022		
		02	CP1-10R-02	1SFA619100R1051	10	0.022		
		10	CP1-30R-10	1SFA619100R3011	10	0.032		
	Chrome metal	01	CP1-30R-01	1SFA619100R3041	10	0.032		
		11	CP1-30R-11	1SFA619100R3071	10	0.036		
		20	CP1-30R-20	1SFA619100R3021	10	0.036		
		02	CP1-30R-02	1SFA619100R3051	10	0.036		
		● Green	Black plastic	10	CP1-10G-10	1SFA619100R1012	10	0.018
				11	CP1-10G-11	1SFA619100R1072	10	0.022
20	CP1-10G-20			1SFA619100R1022	10	0.022		
Chrome metal	10		CP1-30G-10	1SFA619100R3012	10	0.032		
	11		CP1-30G-11	1SFA619100R3072	10	0.036		
	20		CP1-30G-20	1SFA619100R3022	10	0.036		
● Yellow	Black plastic	10	CP1-10Y-10	1SFA619100R1013	10	0.018		
		11	CP1-10Y-11	1SFA619100R1073	10	0.022		
		20	CP1-10Y-20	1SFA619100R1023	10	0.022		
	Chrome metal	10	CP1-30Y-10	1SFA619100R3013	10	0.032		
		11	CP1-30Y-11	1SFA619100R3073	10	0.036		
		20	CP1-30Y-20	1SFA619100R3023	10	0.036		
● Blue	Black plastic	10	CP1-10L-10	1SFA619100R1014	10	0.018		
		11	CP1-10L-11	1SFA619100R1074	10	0.022		
		20	CP1-10L-20	1SFA619100R1024	10	0.022		
	Chrome metal	10	CP1-30L-10	1SFA619100R3014	10	0.032		
		11	CP1-30L-11	1SFA619100R3074	10	0.036		
		20	CP1-30L-20	1SFA619100R3024	10	0.036		
○ White	Black plastic	10	CP1-10W-10	1SFA619100R1015	10	0.018		
		11	CP1-10W-11	1SFA619100R1075	10	0.022		
		20	CP1-10W-20	1SFA619100R1025	10	0.022		
	Chrome metal	10	CP1-30W-10	1SFA619100R3015	10	0.032		
		11	CP1-30W-11	1SFA619100R3075	10	0.036		
		20	CP1-30W-20	1SFA619100R3025	10	0.036		
● Black	Black plastic	10	CP1-10B-10	1SFA619100R1016	10	0.018		
		01	CP1-10B-01	1SFA619100R1046	10	0.018		
		11	CP1-10B-11	1SFA619100R1076	10	0.022		
		20	CP1-10B-20	1SFA619100R1026	10	0.022		
		02	CP1-10B-02	1SFA619100R1056	10	0.022		
		10	CP1-30B-10	1SFA619100R3016	10	0.032		
	Chrome metal	01	CP1-30B-01	1SFA619100R3046	10	0.032		
		11	CP1-30B-11	1SFA619100R3076	10	0.036		
		20	CP1-30B-20	1SFA619100R3026	10	0.036		
		02	CP1-30B-02	1SFA619100R3056	10	0.036		

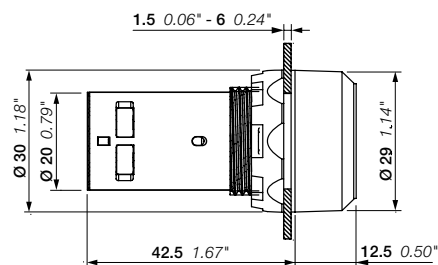

CP1
Dimensions (mm, inches)

Compact range

Non-illuminated flush pushbuttons - Maintained



Operator	Bezel	Contacts	Type	Order code	Pkg qty	Weight (1 pce)
						kg
● Red	Black plastic	10	CP2-10R-10	1SFA619101R1011	10	0.018
		01	CP2-10R-01	1SFA619101R1041	10	0.018
		11	CP2-10R-11	1SFA619101R1071	10	0.022
		20	CP2-10R-20	1SFA619101R1021	10	0.022
		02	CP2-10R-02	1SFA619101R1051	10	0.022
		10	CP2-30R-10	1SFA619101R3011	10	0.032
	Chrome metal	01	CP2-30R-01	1SFA619101R3041	10	0.032
		11	CP2-30R-11	1SFA619101R3071	10	0.036
		20	CP2-30R-20	1SFA619101R3021	10	0.036
		02	CP2-30R-02	1SFA619101R3051	10	0.036
		10	CP2-10G-10	1SFA619101R1012	10	0.018
		11	CP2-10G-11	1SFA619101R1072	10	0.022
● Green	Black plastic	20	CP2-10G-20	1SFA619101R1022	10	0.022
		10	CP2-30G-10	1SFA619101R3012	10	0.032
		11	CP2-30G-11	1SFA619101R3072	10	0.036
		20	CP2-30G-20	1SFA619101R3022	10	0.036
		10	CP2-10Y-10	1SFA619101R1013	10	0.018
		11	CP2-10Y-11	1SFA619101R1073	10	0.022
● Yellow	Black plastic	20	CP2-10Y-20	1SFA619101R1023	10	0.022
		11	CP2-30Y-11	1SFA619101R3073	10	0.036
		20	CP2-30Y-20	1SFA619101R3023	10	0.036
		10	CP2-10L-10	1SFA619101R1014	10	0.018
		11	CP2-10L-11	1SFA619101R1074	10	0.022
		20	CP2-10L-20	1SFA619101R1024	10	0.022
● Blue	Black plastic	10	CP2-30L-10	1SFA619101R3014	10	0.032
		20	CP2-30L-20	1SFA619101R3024	10	0.036
		10	CP2-10W-10	1SFA619101R1015	10	0.018
		11	CP2-10W-11	1SFA619101R1075	10	0.022
		20	CP2-10W-20	1SFA619101R1025	10	0.022
		10	CP2-30W-10	1SFA619101R3015	10	0.032
○ White	Black plastic	20	CP2-30W-20	1SFA619101R3025	10	0.036
		10	CP2-10B-10	1SFA619101R1016	10	0.018
		01	CP2-10B-01	1SFA619101R1046	10	0.018
		11	CP2-10B-11	1SFA619101R1076	10	0.022
		20	CP2-10B-20	1SFA619101R1026	10	0.022
		02	CP2-10B-02	1SFA619101R1056	10	0.022
● Black	Black plastic	10	CP2-30B-10	1SFA619101R3016	10	0.032
		01	CP2-30B-01	1SFA619101R3046	10	0.032
		11	CP2-30B-11	1SFA619101R3076	10	0.036
		20	CP2-30B-20	1SFA619101R3026	10	0.036
		10	CP2-30B-10	1SFA619101R3016	10	0.032
		01	CP2-30B-01	1SFA619101R3046	10	0.032
	Chrome metal	11	CP2-30B-11	1SFA619101R3076	10	0.036
20		CP2-30B-20	1SFA619101R3026	10	0.036	

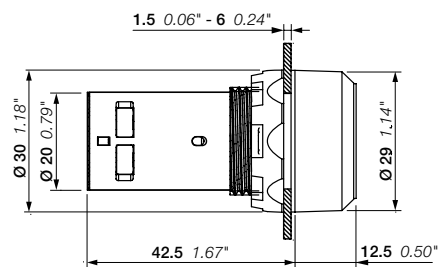

CP2
Dimensions (mm, inches)

Compact range

Non-illuminated extended pushbuttons - Momentary



Operator	Bezel	Contacts	Type	Order code	Pkg qty	Weight (1 pce)		
						kg		
● Red	Black plastic	10	CP3-10R-10	1SFA619102R1011	10	0.019		
		01	CP3-10R-01	1SFA619102R1041	10	0.019		
		11	CP3-10R-11	1SFA619102R1071	10	0.022		
		20	CP3-10R-20	1SFA619102R1021	10	0.022		
		02	CP3-10R-02	1SFA619102R1051	10	0.022		
		01	CP3-30R-01	1SFA619102R3041	10	0.033		
	Chrome metal	11	CP3-30R-11	1SFA619102R3071	10	0.036		
		20	CP3-30R-20	1SFA619102R3021	10	0.036		
		● Green	Black plastic	10	CP3-10G-10	1SFA619102R1012	10	0.019
				11	CP3-10G-11	1SFA619102R1072	10	0.022
				20	CP3-10G-20	1SFA619102R1022	10	0.022
			Chrome metal	10	CP3-30G-10	1SFA619102R3012	10	0.033
11	CP3-30G-11			1SFA619102R3072	10	0.036		
20	CP3-30G-20			1SFA619102R3022	10	0.036		
● Yellow	Black plastic	10	CP3-10Y-10	1SFA619102R1013	10	0.019		
		11	CP3-10Y-11	1SFA619102R1073	10	0.022		
		20	CP3-10Y-20	1SFA619102R1023	10	0.022		
	Chrome metal	20	CP3-30Y-20	1SFA619102R3023	10	0.036		
		● Blue	Black plastic	10	CP3-10L-10	1SFA619102R1014	10	0.019
				11	CP3-10L-11	1SFA619102R1074	10	0.022
20	CP3-10L-20			1SFA619102R1024	10	0.022		
Chrome metal	20		CP3-30L-20	1SFA619102R3024	10	0.036		
	○ White		Black plastic	10	CP3-10W-10	1SFA619102R1015	10	0.019
				11	CP3-10W-11	1SFA619102R1075	10	0.022
20		CP3-10W-20		1SFA619102R1025	10	0.022		
Chrome metal		10	CP3-30W-10	1SFA619102R3015	10	0.033		
		11	CP3-30W-11	1SFA619102R3075	10	0.036		
		20	CP3-30W-20	1SFA619102R3025	10	0.036		
● Black	Black plastic	10	CP3-10B-10	1SFA619102R1016	10	0.019		
		01	CP3-10B-01	1SFA619102R1046	10	0.019		
		11	CP3-10B-11	1SFA619102R1076	10	0.022		
		20	CP3-10B-20	1SFA619102R1026	10	0.022		
		02	CP3-10B-02	1SFA619102R1056	10	0.022		
		10	CP3-30B-10	1SFA619102R3016	10	0.033		
	Chrome metal	01	CP3-30B-01	1SFA619102R3046	10	0.033		
		11	CP3-30B-11	1SFA619102R3076	10	0.036		
		20	CP3-30B-20	1SFA619102R3026	10	0.036		

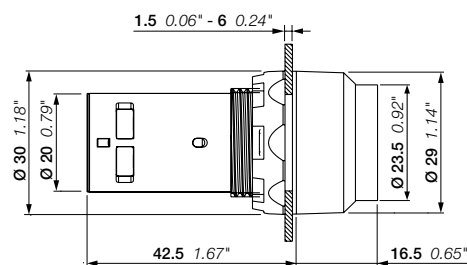

CP3
Dimensions (mm, inches)

Compact range

Non-illuminated extended pushbuttons - Maintained



Operator	Bezel	Contacts	Type	Order code	Pkg qty	Weight (1 pce)
						kg
● Red	Black plastic		CP4-10R-10	1SFA619103R1011	10	0.019
			CP4-10R-01	1SFA619103R1041	10	0.019
			CP4-10R-11	1SFA619103R1071	10	0.022
			CP4-10R-20	1SFA619103R1021	10	0.022
			CP4-10R-02	1SFA619103R1051	10	0.022
● Green	Black plastic		CP4-30R-11	1SFA619103R3071	10	0.036
			CP4-10G-10	1SFA619103R1012	10	0.019
			CP4-10G-11	1SFA619103R1072	10	0.022
			CP4-10G-20	1SFA619103R1022	10	0.022
			CP4-10G-02	1SFA619103R3012	10	0.033
● Yellow	Black plastic		CP4-30G-10	1SFA619103R3012	10	0.033
			CP4-10Y-10	1SFA619103R1013	10	0.019
			CP4-10Y-11	1SFA619103R1073	10	0.022
● Blue	Black plastic		CP4-10L-10	1SFA619103R1014	10	0.019
			CP4-10L-11	1SFA619103R1074	10	0.022
○ White	Black plastic		CP4-10W-10	1SFA619103R1015	10	0.019
			CP4-10W-11	1SFA619103R1075	10	0.022
● Black	Black plastic		CP4-10B-10	1SFA619103R1016	10	0.019
			CP4-10B-11	1SFA619103R1076	10	0.022
			CP4-10B-20	1SFA619103R1026	10	0.022
			CP4-10B-02	1SFA619103R1056	10	0.022

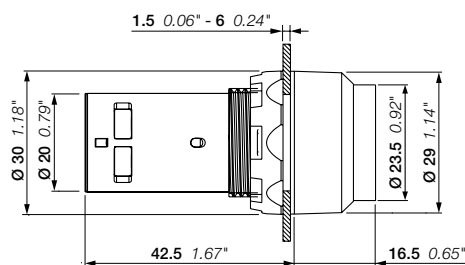

CP4
Dimensions (mm, inches)

Compact range

Illuminated flush pushbuttons - Momentary



CP1-11R-10

1SFCL5115V0001



CP1-11G-10

1SFCL51188V0001



CP1-31Y-10

1SFCL51189V0001



CP1-11L-10

1SFCL51149V0001



CP1-31C-10

1SFCL51175V0001

Operator	Bezel	Contacts	Type	Order code	Pkg qty	Weight (1 pce)
						kg



Rated voltage 24 V AC / DC

● Red	Black plastic	1 0	CP1-11R-10	1SFA619100R1111	10	0.025
		0 1	CP1-11R-01	1SFA619100R1141	10	0.025
	Chrome metal	1 0	CP1-31R-10	1SFA619100R3111	10	0.039
		0 1	CP1-31R-01	1SFA619100R3141	10	0.039
● Green	Black plastic	1 0	CP1-11G-10	1SFA619100R1112	10	0.025
	Chrome metal	1 0	CP1-31G-10	1SFA619100R3112	10	0.039
● Yellow	Black plastic	1 0	CP1-11Y-10	1SFA619100R1113	10	0.025
	Chrome metal	1 0	CP1-31Y-10	1SFA619100R3113	10	0.039
● Blue	Black plastic	1 0	CP1-11L-10	1SFA619100R1114	10	0.025
	Chrome metal	1 0	CP1-31L-10	1SFA619100R3114	10	0.039
		0 1	CP1-31L-01	1SFA619100R3144	10	0.039
○ Clear	Black plastic	1 0	CP1-11C-10	1SFA619100R1118	10	0.025
	Chrome metal	1 0	CP1-31C-10	1SFA619100R3118	10	0.039

Rated voltage 110...130 V AC / DC

● Red	Black plastic	1 0	CP1-12R-10	1SFA619100R1211	10	0.025
		0 1	CP1-12R-01	1SFA619100R1241	10	0.025
● Green	Black plastic	1 0	CP1-12G-10	1SFA619100R1212	10	0.025
● Yellow	Black plastic	1 0	CP1-12Y-10	1SFA619100R1213	10	0.025
● Blue	Black plastic	1 0	CP1-12L-10	1SFA619100R1214	10	0.025
○ Clear	Black plastic	1 0	CP1-12C-10	1SFA619100R1218	10	0.025

Rated voltage 220 V AC / DC

● Red	Black plastic	1 0	CP1-13R-10	1SFA619100R1311	10	0.025
		0 1	CP1-13R-01	1SFA619100R1341	10	0.025
● Green	Black plastic	1 0	CP1-13G-10	1SFA619100R1312	10	0.025
● Yellow	Black plastic	1 0	CP1-13Y-10	1SFA619100R1313	10	0.025
● Blue	Black plastic	1 0	CP1-13L-10	1SFA619100R1314	10	0.025
○ Clear	Black plastic	1 0	CP1-13C-10	1SFA619100R1318	10	0.025

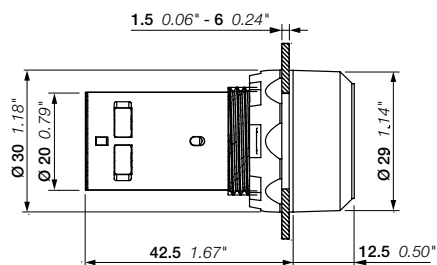

CP1

Dimensions (mm, inches)

Compact range

Illuminated flush pushbuttons - Maintained



Operator	Bezel	Contacts	Type	Order code	Pkg qty	Weight (1 pce)
kg						
Rated voltage 24 V AC / DC						
● Red	Black plastic	1 0	CP2-11R-10	1SFA619101R1111	10	0.025
		0 1	CP2-11R-01	1SFA619101R1141	10	0.025
● Green	Black plastic	1 0	CP2-11G-10	1SFA619101R1112	10	0.025
● Yellow	Black plastic	1 0	CP2-11Y-10	1SFA619101R1113	10	0.025
● Blue	Black plastic	1 0	CP2-11L-10	1SFA619101R1114	10	0.025
○ Clear	Black plastic	1 0	CP2-11C-10	1SFA619101R1118	10	0.025
Rated voltage 110...130 V AC / DC						
● Red	Black plastic	1 0	CP2-12R-10	1SFA619101R1211	10	0.025
		0 1	CP2-12R-01	1SFA619101R1241	10	0.025
● Green	Black plastic	1 0	CP2-12G-10	1SFA619101R1212	10	0.025
● Yellow	Black plastic	1 0	CP2-12Y-10	1SFA619101R1213	10	0.025
● Blue	Black plastic	1 0	CP2-12L-10	1SFA619101R1214	10	0.025
○ Clear	Black plastic	1 0	CP2-12C-10	1SFA619101R1218	10	0.025
Rated voltage 220 V AC / DC						
● Red	Black plastic	1 0	CP2-13R-10	1SFA619101R1311	10	0.025
		0 1	CP2-13R-01	1SFA619101R1341	10	0.025
● Green	Black plastic	1 0	CP2-13G-10	1SFA619101R1312	10	0.025
● Yellow	Black plastic	1 0	CP2-13Y-10	1SFA619101R1313	10	0.025
● Blue	Black plastic	1 0	CP2-13L-10	1SFA619101R1314	10	0.025
○ Clear	Black plastic	1 0	CP2-13C-10	1SFA619101R1318	10	0.025

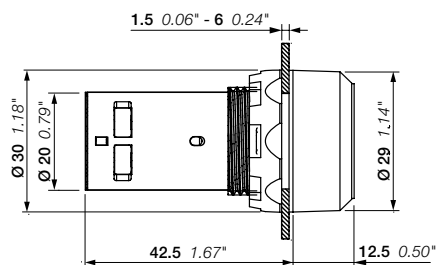

CP1
Dimensions (mm, inches)

Compact range

Illuminated extended pushbuttons - Momentary



CP3-11R-10



CP3-11G-10



CP3-11Y-10

Operator	Bezel	Contacts	Type	Order code	Pkg qty	Weight (1 pce)
kg						
Rated voltage 24 V AC / DC						
● Red	Black plastic	1 0	CP3-11R-10	1SFA619102R1111	10	0.025
		0 1	CP3-11R-01	1SFA619102R1141	10	0.025
● Green	Black plastic	1 0	CP3-11G-10	1SFA619102R1112	10	0.025
● Yellow	Black plastic	1 0	CP3-11Y-10	1SFA619102R1113	10	0.025
● Blue	Black plastic	1 0	CP3-11L-10	1SFA619102R1114	10	0.025
○ Clear	Black plastic	1 0	CP3-11C-10	1SFA619102R1118	10	0.025
Rated voltage 110...130 V AC / DC						
● Red	Black plastic	1 0	CP3-12R-10	1SFA619102R1211	10	0.025
		0 1	CP3-12R-01	1SFA619102R1241	10	0.025
● Green	Black plastic	1 0	CP3-12G-10	1SFA619102R1212	10	0.025
● Yellow	Black plastic	1 0	CP3-12Y-10	1SFA619102R1213	10	0.025
● Blue	Black plastic	1 0	CP3-12L-10	1SFA619102R1214	10	0.025
○ Clear	Black plastic	1 0	CP3-12C-10	1SFA619102R1218	10	0.025
Rated voltage 220 V AC / DC						
● Red	Black plastic	1 0	CP3-13R-10	1SFA619102R1311	10	0.025
		0 1	CP3-13R-01	1SFA619102R1341	10	0.025
● Green	Black plastic	1 0	CP3-13G-10	1SFA619102R1312	10	0.025
● Yellow	Black plastic	1 0	CP3-13Y-10	1SFA619102R1313	10	0.025
● Blue	Black plastic	1 0	CP3-13L-10	1SFA619102R1314	10	0.025
○ Clear	Black plastic	1 0	CP3-13C-10	1SFA619102R1318	10	0.025

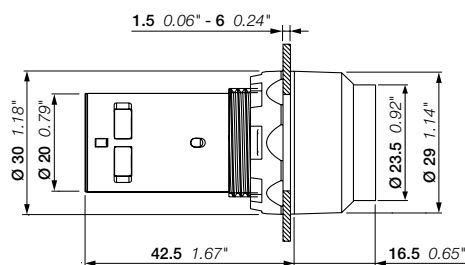

CP3

Dimensions (mm, inches)

Compact range

Illuminated extended pushbuttons - Maintained



CP4-11R-10

1SFC151210V0001



CP4-11G-10

1SFC151213V0001



CP4-11Y-10

1SFC151208V0001

Operator	Bezel	Contacts	Type	Order code	Pkg qty	Weight (1 pce)
kg						
Rated voltage 24 V AC / DC						
● Red	Black plastic	1 0	CP4-11R-10	1SFA619103R1111	10	0.025
		0 1	CP4-11R-01	1SFA619103R1141	10	0.025
● Green	Black plastic	1 0	CP4-11G-10	1SFA619103R1112	10	0.025
● Yellow	Black plastic	1 0	CP4-11Y-10	1SFA619103R1113	10	0.025
● Blue	Black plastic	1 0	CP4-11L-10	1SFA619103R1114	10	0.025
○ Clear	Black plastic	1 0	CP4-11C-10	1SFA619103R1118	10	0.025
Rated voltage 110...130 V AC / DC						
● Red	Black plastic	1 0	CP4-12R-10	1SFA619103R1211	10	0.025
		0 1	CP4-12R-01	1SFA619103R1241	10	0.025
● Green	Black plastic	1 0	CP4-12G-10	1SFA619103R1212	10	0.025
● Yellow	Black plastic	1 0	CP4-12Y-10	1SFA619103R1213	10	0.025
● Blue	Black plastic	1 0	CP4-12L-10	1SFA619103R1214	10	0.025
○ Clear	Black plastic	1 0	CP4-12C-10	1SFA619103R1218	10	0.025
Rated voltage 230 V AC / DC						
● Red	Black plastic	1 0	CP4-13R-10	1SFA619103R1311	10	0.025
		0 1	CP4-13R-01	1SFA619103R1341	10	0.025
● Green	Black plastic	1 0	CP4-13G-10	1SFA619103R1312	10	0.025
● Yellow	Black plastic	1 0	CP4-13Y-10	1SFA619103R1313	10	0.025
● Blue	Black plastic	1 0	CP4-13L-10	1SFA619103R1314	10	0.025
○ Clear	Black plastic	1 0	CP4-13C-10	1SFA619103R1318	10	0.025

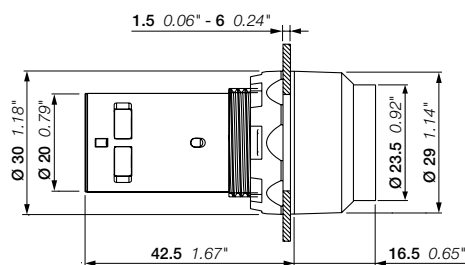

CP4
Dimensions (mm, inches)

Compact range

Non-illuminated mushroom pushbuttons - Momentary



CPM3-10R-11



CPM3-10G-11



CPM3-10Y-11



CPM3-10L-11



CPM3-10B-11

Operator	Contacts	Type	Order code	Pkg qty	Weight (1 pce)
					
kg					
Ø 40 mm					
● Red	1 1	CPM3-10R-11	1SFA619126R1071	1	0.036
● Green	1 1	CPM3-10G-11	1SFA619126R1072	1	0.036
● Yellow	1 1	CPM3-10Y-11	1SFA619126R1073	1	0.036
● Blue	1 1	CPM3-10L-11	1SFA619126R1074	1	0.036
● Black	1 1	CPM3-10B-11	1SFA619126R1076	1	0.036

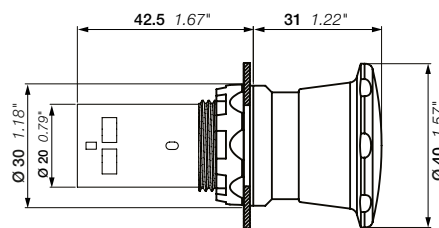

CPM3
Dimensions (mm, inches)

Compact range

Non-illuminated emergency stop pushbuttons

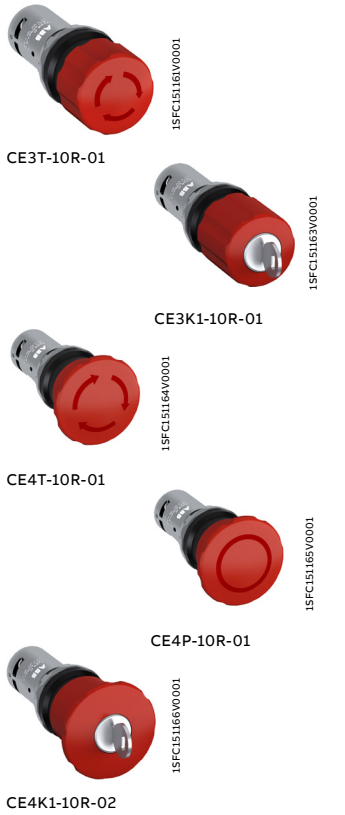

Description

The emergency stop pushbuttons conform to the standard EN/IEC 60947-5-5, Safety of machinery standard EN/ISO 13850, IEC 60204-1 and to Machinery directive 2006/42/EC.

Operator	Release method	Contacts	Type	Order code	Pkg qty	Weight (1 pce)
Ø 30 mm						
● Red	Twist release	0 1	CE3T-10R-01	1SFA619500R1041	1	0.032
		1 1	CE3T-10R-11	1SFA619500R1071	1	0.032
		0 2	CE3T-10R-02	1SFA619500R1051	1	0.032
● Red	Pull release	0 1	CE3P-10R-01	1SFA619501R1041	1	0.032
		1 1	CE3P-10R-11	1SFA619501R1071	1	0.032
		0 2	CE3P-10R-02	1SFA619501R1051	1	0.032
● Red	Key code 455	0 1	CE3K1-10R-01	1SFA619502R1041	1	0.060
		1 1	CE3K1-10R-11	1SFA619502R1071	1	0.060
		0 2	CE3K1-10R-02	1SFA619502R1051	1	0.060
Ø 40 mm						
● Red	Twist release	0 1	CE4T-10R-01	1SFA619550R1041	1	0.036
		1 1	CE4T-10R-11	1SFA619550R1071	1	0.036
		0 2	CE4T-10R-02	1SFA619550R1051	1	0.036
● Red	Pull release	0 1	CE4P-10R-01	1SFA619551R1041	1	0.036
		1 1	CE4P-10R-11	1SFA619551R1071	1	0.036
		0 2	CE4P-10R-02	1SFA619551R1051	1	0.036
● Red	Key code 455	0 1	CE4K1-10R-01	1SFA619552R1041	1	0.064
		1 1	CE4K1-10R-11	1SFA619552R1071	1	0.064
		0 2	CE4K1-10R-02	1SFA619552R1051	1	0.064

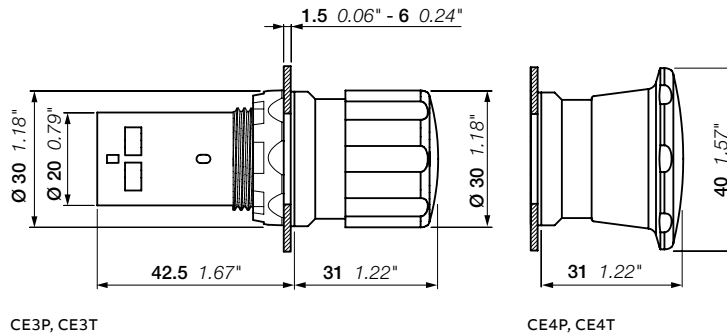

CE3P, CE3T

CE4P, CE4T

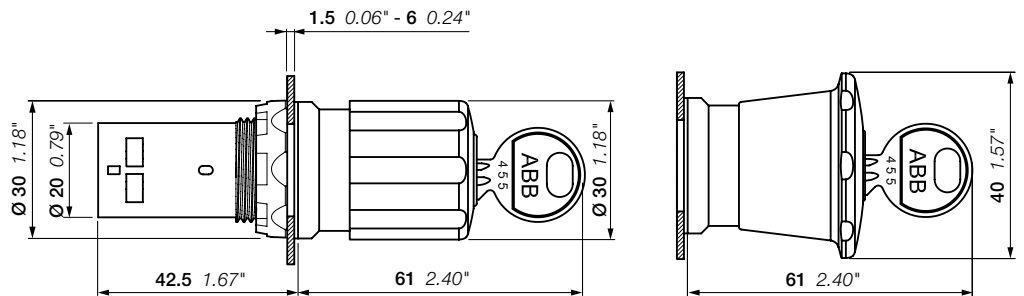

CE3K

CE4K

Dimensions (mm, inches)

Compact range

Non-illuminated machine stop pushbuttons



Operator	Release method	Contacts	Type	Order code	Pkg qty	Weight (1 pce)
kg						
Ø 30 mm						
● Black	Twist release	0 1	CE3T-10B-01	1SFA619500R1046	1	0.032
		1 1	CE3T-10B-11	1SFA619500R1076	1	0.032
● Black	Pull release	1 1	CE3P-10B-11	1SFA619501R1076	1	0.032
● Black	Key code 455	1 1	CE3K1-10B-11	1SFA619502R1076	1	0.060
Ø 40 mm						
● Black	Twist release	1 0	CE4T-10B-10	1SFA619550R1016	1	0.032
		0 1	CE4T-10B-01	1SFA619550R1046	1	0.032
		1 1	CE4T-10B-11	1SFA619550R1076	1	0.032
		2 0	CE4T-10B-20	1SFA619550R1026	1	0.032
		0 2	CE4T-10B-02	1SFA619550R1056	1	0.032
● Black	Pull release	1 1	CE4P-10B-11	1SFA619551R1076	1	0.032
● Black	Key code 455	1 1	CE4K1-10B-11	1SFA619552R1076	1	0.064

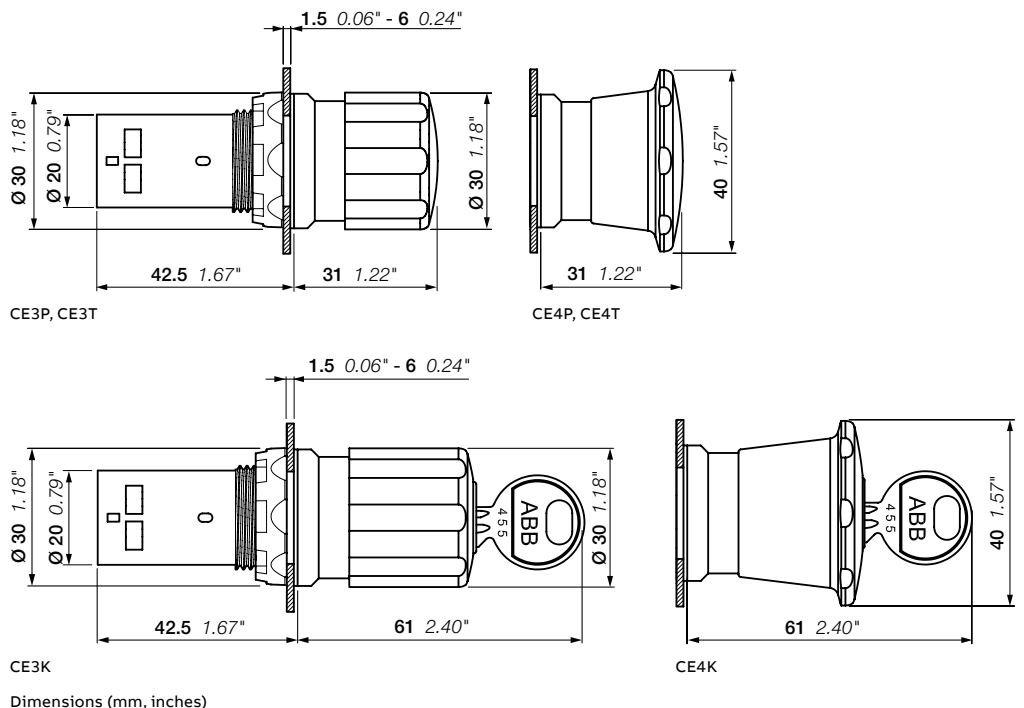

Compact range

Heavy duty pushbuttons



15FC151025V0001

CP6-10R-11



15FC151024V0001

CP6-10G-11



15FC151023V0001

CP6-10B-11

Description

Silicone rubber cap.

Color	Contacts	Type	Order code	Pkg qty	Weight (1 pce)
● Red	1 1	CP6-10R-11	1SFA619105R1071	10	0.031
	2 0	CP6-10R-20	1SFA619105R1021	10	0.031
	0 2	CP6-10R-02	1SFA619105R1051	10	0.031
● Green	1 1	CP6-10G-11	1SFA619105R1072	10	0.031
	2 0	CP6-10G-20	1SFA619105R1022	10	0.031
● Black	1 1	CP6-10B-11	1SFA619105R1076	10	0.031
	2 0	CP6-10B-20	1SFA619105R1026	10	0.031
	0 2	CP6-10B-02	1SFA619105R1056	10	0.031

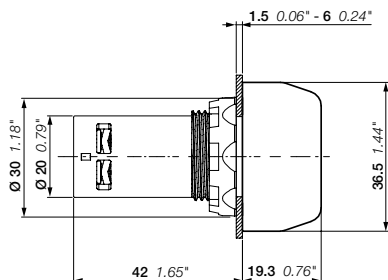

CP6

Dimensions (mm, inches)

Compact range

Pilot lights



1SFC151338V0001

CL2-502R



1SFC151339V0001

CL2-506G



1SFC151340V0001

CL2-508Y



1SFC151341V0001

CL2-506L



1SFC151342V0001

CL2-506C

Description

Integrated LED, no bulb needed.

Color	Rated current mA	Anti-in-ductive voltage Vpeak	Wave-length nm	Illumi-nation lx	Type	Order code	Pkg qty	Weight (1 pce) kg
-------	---------------------	----------------------------------	-------------------	---------------------	------	------------	---------	----------------------

Voltage 6.3 V

● Red	16	2	625	70	CL2-506R	1SFA619403R5061	10	0.016
● Green	16	2	520	125	CL2-506G	1SFA619403R5062	10	0.016
● Yellow	16	2	590	75	CL2-506Y	1SFA619403R5063	10	0.016
● Blue	16	2	470	10	CL2-506L	1SFA619403R5064	10	0.016
○ Clear	16	2	(1)	290	CL2-506C	1SFA619403R5068	10	0.016

Voltage 12 V DC

● Red	16	2	625	110	CL2-501R	1SFA619403R5011	10	0.016
● Green	16	2.5	520	165	CL2-501G	1SFA619403R5012	10	0.016
● Yellow	16	2.5	590	85	CL2-501Y	1SFA619403R5013	10	0.016
● Blue	16	2.5	470	15	CL2-501L	1SFA619403R5014	10	0.016
○ Clear	16	2.5	(1)	320	CL2-501C	1SFA619403R5018	10	0.016

Voltage 24 V AC / DC

● Red	16	6	625	80	CL2-502R	1SFA619403R5021	10	0.016
● Green	16	6	520	135	CL2-502G	1SFA619403R5022	10	0.016
● Yellow	16	6	590	55	CL2-502Y	1SFA619403R5023	10	0.016
● Blue	16	6	470	10	CL2-502L	1SFA619403R5024	10	0.016
○ Clear	16	6	(1)	230	CL2-502C	1SFA619403R5028	10	0.016

Voltage 48 ... 60 V AC / DC

● Red	13-17	7	625	75	CL2-507R	1SFA619403R5071	10	0.016
● Green	13-17	7	520	140	CL2-507G	1SFA619403R5072	10	0.016
● Yellow	13-17	7	590	80	CL2-507Y	1SFA619403R5073	10	0.016
● Blue	13-17	7	470	10	CL2-507L	1SFA619403R5074	10	0.016
○ Clear	13-17	7	(1)	260	CL2-507C	1SFA619403R5078	10	0.016

Voltage 110 ... 130 V AC

● Red	15-17	20	625	85	CL2-513R	1SFA619403R5131	10	0.016
● Green	15-17	20	520	90	CL2-513G	1SFA619403R5132	10	0.016
● Yellow	15-17	20	590	85	CL2-513Y	1SFA619403R5133	10	0.016
● Blue	15-17	20	470	10	CL2-513L	1SFA619403R5134	10	0.016
○ Clear	15-17	20	(1)	340	CL2-513C	1SFA619403R5138	10	0.016

Voltage 110 ... 130 V DC

● Red	8-9	20	625	55	CL2-515R	1SFA619403R5151	10	0.016
● Green	8-9	20	520	125	CL2-515G	1SFA619403R5152	10	0.016
● Yellow	8-9	20	590	50	CL2-515Y	1SFA619403R5153	10	0.016
● Blue	8-9	20	470	10	CL2-515L	1SFA619403R5154	10	0.016
○ Clear	8-9	20	(1)	210	CL2-515C	1SFA619403R5158	10	0.016

(1) X = 0.31, Y = 0.32

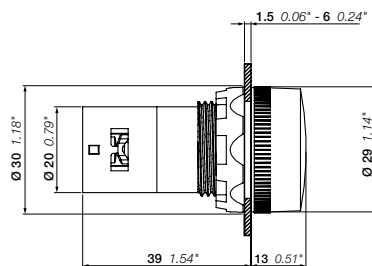

CL2

Dimensions (mm, inches)

Compact range

Pilot lights



CL2-502R

1SFCL151338V0001



CL2-506G

1SFCL151339V0001



CL2-508Y

1SFCL151340V0001



CL2-506L

1SFCL151341V0001



CL2-506C

1SFCL151342V0001

Description

Integrated LED, no bulb needed.

Color	Rated current mA	Anti-inductive voltage Vpeak	Wave-length nm	Illumi-nation lx	Type	Order code	Pkg qty	Weight (1 pce) kg
-------	---------------------	---------------------------------	-------------------	---------------------	------	------------	---------	----------------------

Voltage 220 V DC

● Red	6	20	625	40	CL2-520R	1SFA619403R5201	10	0.016
● Green	6	20	520	90	CL2-520G	1SFA619403R5202	10	0.016
● Yellow	6	20	590	30	CL2-520Y	1SFA619403R5203	10	0.016
● Blue	6	20	470	5	CL2-520L	1SFA619403R5204	10	0.016
○ Clear	6	20	(1)	120	CL2-520C	1SFA619403R5208	10	0.016

Voltage 230 V AC

● Red	17	30	625	95	CL2-523R	1SFA619403R5231	10	0.016
● Green	17	35	520	155	CL2-523G	1SFA619403R5232	10	0.016
● Yellow	17	35	590	70	CL2-523Y	1SFA619403R5233	10	0.016
● Blue	17	35	470	10	CL2-523L	1SFA619403R5234	10	0.016
○ Clear	17	35	(1)	225	CL2-523C	1SFA619403R5238	10	0.016

Rated voltage 230 V AC high anti-inductive voltage (2)

● Red	17	60	625	75	CL2-623R	1SFA619403R6231	10	0.016
● Green	17	80	520	70	CL2-623G	1SFA619403R6232	10	0.016
● Yellow	17	70	590	50	CL2-623Y	1SFA619403R6233	10	0.016
● Blue	17	80	470	5	CL2-623L	1SFA619403R6234	10	0.016
○ Clear	17	80	(1)	155	CL2-623C	1SFA619403R6238	10	0.016

Rated voltage 380 ... 415 V AC

● Red	15-17	55	625	85	CL2-542R	1SFA619403R5421	10	0.016
● Green	15-17	65	520	130	CL2-542G	1SFA619403R5422	10	0.016
● Yellow	15-17	65	590	60	CL2-542Y	1SFA619403R5423	10	0.016
● Blue	15-17	65	470	10	CL2-542L	1SFA619403R5424	10	0.016
○ Clear	15-17	65	(1)	395	CL2-542C	1SFA619403R5428	10	0.016

(1) X = 0.31, Y = 0.32

(2) Higher threshold to light up LED to be used in application where there is risk of large induced voltages.

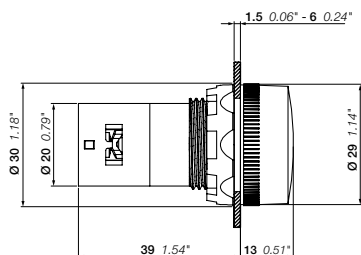

CL2

Dimensions (mm, inches)

Compact range

Pilot lights BA 9s



CL-100R



CL-100L

Description

Bulb not included and should be ordered separately, see Accessories section for order codes and information.

Color	Type	Order code	Pkg qty	Weight (1 pce) kg
● Red	CL-100R	1SFA619402R1001	10	0.018
● Green	CL-100G	1SFA619402R1002	10	0.018
● Yellow	CL-100Y	1SFA619402R1003	10	0.018
● Blue	CL-100L	1SFA619402R1004	10	0.018
○ White	CL-100W	1SFA619402R1005	10	0.018
○ Clear	CL-100C	1SFA619402R1008	10	0.018

Accessories for compact range

Flashing LED bulbs for CL-100 pilot lights

Color	Wavelength nm	Type	Order code	Pkg qty	Weight (1 pce) kg
Rated voltage 24 V DC rated current 25 mA, service life > 50 000 h					
● Red	630	–	4950512-1	20	0.005
● Green	565	–	4950512-2	20	0.005
● Yellow	585	–	4950512-3	20	0.005

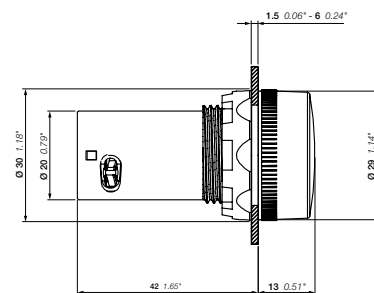

CL100
Dimensions (mm, inches)

Accessories for compact range

LED bulbs for CL-100 pilot lights



KA2...

1SFC151178F0001

Color	Wavelength nm	Luminance mdc	Type	Order code	Pkg qty	Weight (1 pce) kg
Rated voltage 12 V DC rated current 15 mA, service life > 50 000 h						
● Red	630	250	KA2-2011	1SFA616921R2011	20	0.005
● Green	525	1000	KA2-2012	1SFA616921R2012	20	0.005
● Yellow	592	250	KA2-2013	1SFA616921R2013	20	0.005
● Blue	470	450	KA2-2014	1SFA616921R2014	20	0.005
○ White	(1)	600	KA2-2015	1SFA616921R2015	20	0.005
Rated voltage 24 V (AC) / DC rated current 15 mA, service life > 50 000 h						
● Red	630	250	KA2-2021	1SFA616921R2021	20	0.005
● Green	525	800	KA2-2022	1SFA616921R2022	20	0.005
● Yellow	592	250	KA2-2023	1SFA616921R2023	20	0.005
● Blue	470	400	KA2-2024	1SFA616921R2024	20	0.005
○ White	(1)	500	KA2-2025	1SFA616921R2025	20	0.005
Rated voltage 36 V (AC) / DC rated current 12 mA, service life > 50 000 h						
● Red	630	200	KA2-2031	1SFA616921R2031	20	0.005
● Green	525	2000	KA2-2032	1SFA616921R2032	20	0.005
● Yellow	592	200	KA2-2033	1SFA616921R2033	20	0.005
● Blue	470	750	KA2-2034	1SFA616921R2034	20	0.005
○ White	(1)	1400	KA2-2035	1SFA616921R2035	20	0.005
Rated voltage 48 V (AC) / DC rated current 12 mA, service life > 50 000 h						
● Red	630	200	KA2-2041	1SFA616921R2041	20	0.005
● Green	525	1700	KA2-2042	1SFA616921R2042	20	0.005
● Yellow	592	240	KA2-2043	1SFA616921R2043	20	0.005
● Blue	470	720	KA2-2044	1SFA616921R2044	20	0.005
○ White	(1)	1200	KA2-2045	1SFA616921R2045	20	0.005
Rated voltage 60 V (AC) / DC rated current 10 mA, service life > 50 000 h						
● Red	630	160	KA2-2051	1SFA616921R2051	20	0.005
● Green	525	1400	KA2-2052	1SFA616921R2052	20	0.005
● Yellow	592	200	KA2-2053	1SFA616921R2053	20	0.005
● Blue	470	600	KA2-2054	1SFA616921R2054	20	0.005
○ White	(1)	1000	KA2-2055	1SFA616921R2055	20	0.005
Rated voltage 110 ... 130 V AC rated current 4-6 mA, service life 25 000 h						
● Red	630	60-100	KA2-2131	1SFA616921R2131	20	0.005
● Green	525	500-850	KA2-2132	1SFA616921R2132	20	0.005
● Yellow	592	70-120	KA2-2133	1SFA616921R2133	20	0.005
● Blue	470	220-350	KA2-2134	1SFA616921R2134	20	0.005
○ White	(1)	350-600	KA2-2135	1SFA616921R2135	20	0.005
Rated voltage 110 ... 130 V (AC) / DC rated current 4-6 mA, service life 25 000 h						
● Red	630	60	KA2-2141	1SFA616921R2141	20	0.005
● Green	525	500	KA2-2142	1SFA616921R2142	20	0.005
● Yellow	592	70	KA2-2143	1SFA616921R2143	20	0.005
● Blue	470	220	KA2-2144	1SFA616921R2144	20	0.005
○ White	(1)	350	KA2-2145	1SFA616921R2145	20	0.005
Rated voltage 230 V AC rated current 4 mA, service life 25 000 h						
● Red	630	60	KA2-2221	1SFA616921R2221	20	0.005
● Green	525	500	KA2-2222	1SFA616921R2222	20	0.005
● Yellow	592	70	KA2-2223	1SFA616921R2223	20	0.005
● Blue	470	220	KA2-2224	1SFA616921R2224	20	0.005
○ White	(1)	350	KA2-2225	1SFA616921R2225	20	0.005
Rated voltage 230 V (AC) / DC rated current 4 mA, service life 25 000 h						
● Red	630	60	KA2-2231	1SFA616921R2231	20	0.005
● Green	525	500	KA2-2232	1SFA616921R2232	20	0.005
● Yellow	592	70	KA2-2233	1SFA616921R2233	20	0.005
● Blue	470	220	KA2-2234	1SFA616921R2234	20	0.005
○ White	(1)	350	KA2-2235	1SFA616921R2235	20	0.005

Note: Choose the same color on the LED as on the lamp cap. (1) X=0.31, Y=0.32 according to the ICI chromaticity diagram.

Compact range

Non-illuminated selector switches - 2-position



C2SS1-10B-10

15FCL15125V0001



C2SS3-30B-10

15FCL15135V0001

Contacts actuated

2-position selector switch
Contacts included,

	actuated in position C			
	NC	NO	NC	NO
	11	13	21	23
	12	14	22	24
1 NO	-	1	-	-
2 NO	-	1	-	1
1 NC	1	-	-	-
2 NC	1	-	1	-
1 NO + 1 NC	-	1	1	-

Description

Compact selector switches are delivered in black color.

Operating principle	Bezel	Contacts	Type	Order code	Pkg qty	Weight (1 pce)
						kg
Short handle						
	Black plastic	1 0	C2SS1-10B-10	1SFA619200R1016	10	0.02
		0 1	C2SS1-10B-01	1SFA619200R1046	10	0.02
		1 1	C2SS1-10B-11	1SFA619200R1076	10	0.024
	Chrome metal	2 0	C2SS1-10B-20	1SFA619200R1026	10	0.024
		1 0	C2SS1-30B-10	1SFA619200R3016	10	0.029
		0 1	C2SS1-30B-01	1SFA619200R3046	10	0.029
	Black plastic	1 1	C2SS1-30B-11	1SFA619200R3076	10	0.032
		2 0	C2SS1-30B-20	1SFA619200R3026	10	0.032
		1 0	C2SS2-10B-10	1SFA619201R1016	10	0.02
	Chrome metal	0 1	C2SS2-10B-01	1SFA619201R1046	10	0.02
		1 1	C2SS2-10B-11	1SFA619201R1076	10	0.024
		2 0	C2SS2-10B-20	1SFA619201R1026	10	0.024
	Black plastic	1 0	C2SS2-30B-10	1SFA619201R3016	10	0.029
		0 1	C2SS2-30B-01	1SFA619201R3046	10	0.029
		1 1	C2SS2-30B-11	1SFA619201R3076	10	0.032
	Chrome metal	2 0	C2SS2-30B-20	1SFA619201R3026	10	0.032
		1 0	C2SS3-10B-10	1SFA619202R1016	10	0.02
		0 1	C2SS3-10B-01	1SFA619202R1046	10	0.02
	Black plastic	1 1	C2SS3-10B-11	1SFA619202R1076	10	0.024
		2 0	C2SS3-10B-20	1SFA619202R1026	10	0.024
		1 0	C2SS3-30B-10	1SFA619202R3016	10	0.029
	Chrome metal	1 1	C2SS3-30B-11	1SFA619202R3076	10	0.032
		2 0	C2SS3-30B-20	1SFA619202R3026	10	0.032
		1 0	C2SS5-30B-10	1SFA619204R3016	10	0.029
	Chrome metal	1 1	C2SS5-30B-11	1SFA619204R3076	10	0.032

Long handle

	Chrome metal	1 0	C2SS5-30B-10	1SFA619204R3016	10	0.029
		1 1	C2SS5-30B-11	1SFA619204R3076	10	0.032

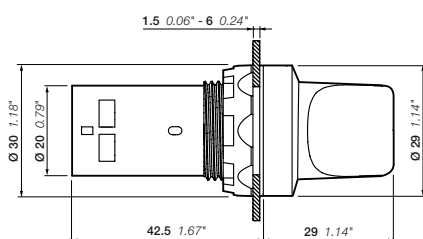

C2SS, short handle
Dimensions (mm, inches)

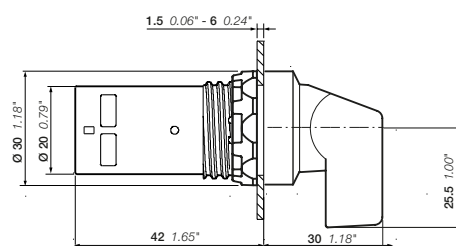

C2SS, long handle

Compact range

Non-illuminated selector switches - 3-position



C3SS1-10B-11



C3SS2-30B-20

Contacts actuated

3-position selector switch
Contacts included,

actuated in position:		A				C			
		NC	NO	NC	NO	NC	NO	NC	NO
		21	23	11	13				
		22	24	12	14				
2 NO		-	1	-	1				
2 NC		1	-	1	-				
1 NO + 1 NC		1	-	-	1				

Description

Compact selector switches operators are delivered in black color.

Operating principle	Bezel	Contacts	Type	Order code	Pkg qty	Weight (1 pce)
						kg

Short handle

	Black plastic	1 1	C3SS1-10B-11	1SFA619210R1076	10	0.024
		2 0	C3SS1-10B-20	1SFA619210R1026	10	0.024
	Chrome metal	1 1	C3SS1-30B-11	1SFA619210R3076	10	0.032
		2 0	C3SS1-30B-20	1SFA619210R3026	10	0.032
	Black plastic	1 1	C3SS2-10B-11	1SFA619211R1076	10	0.024
		2 0	C3SS2-10B-20	1SFA619211R1026	10	0.024
	Chrome metal	1 1	C3SS2-30B-11	1SFA619211R3076	10	0.032
		2 0	C3SS2-30B-20	1SFA619211R3026	10	0.032
	Black plastic	1 1	C3SS3-10B-11	1SFA619212R1076	10	0.024
		2 0	C3SS3-10B-20	1SFA619212R1026	10	0.024
	Chrome metal	1 1	C3SS3-30B-11	1SFA619212R3076	10	0.032
		2 0	C3SS3-30B-20	1SFA619212R3026	10	0.032
	Black plastic	1 1	C3SS7-10B-11	1SFA619216R1076	10	0.024
		2 0	C3SS7-10B-20	1SFA619216R1026	10	0.024
	Chrome metal	2 0	C3SS7-30B-20	1SFA619216R3026	10	0.032

Long handle

	Black plastic	1 1	C3SS4-10B-11	1SFA619213R1076	10	0.024
		2 0	C3SS4-10B-20	1SFA619213R1026	10	0.024
	Black plastic	1 1	C3SS5-10B-11	1SFA619214R1076	10	0.024
		2 0	C3SS5-10B-20	1SFA619214R1026	10	0.024
	Chrome metal	2 0	C3SS5-30B-20	1SFA619214R3026	10	0.032

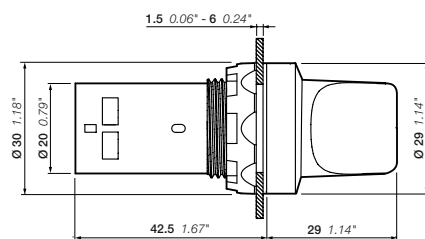

C3SS, short handle
Dimensions (mm, inches)

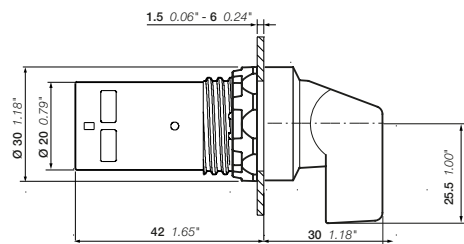

C3SS, long handle

Compact range

Buzzers



1SFC15151V0001

CB1-600G



1SFC15159V0001

CB1-610R



1SFC15158V0001

CB1-610Y



1SFC15160V0001

CB1-620B

Illuminated

Color	Light and sound output	Rated current mA	Luminance mcd	Type	Order code	Pkg qty	Weight (1 pce) kg
-------	------------------------	---------------------	------------------	------	------------	---------	----------------------

Rated voltage 24 V AC / DC

● Green	Continuous	48	126	CB1-600G	1SFA619600R6002	10	0.021
● Red	Pulsation	53	60	CB1-610R	1SFA619600R6101	10	0.021
● Yellow	Pulsation	53	60	CB1-610Y	1SFA619600R6103	10	0.021

Rated voltage 110 ... 130 V AC

● Green	Continuous	55	126	CB1-601G	1SFA619600R6012	10	0.021
● Red	Pulsation	70	60	CB1-611R	1SFA619600R6111	10	0.021
● Yellow	Pulsation	70	60	CB1-611Y	1SFA619600R6113	10	0.021

Rated voltage 110 ... 130 V DC

● Green	Continuous	15	126	CB1-602G	1SFA619600R6022	10	0.021
● Red	Pulsation	15	60	CB1-612R	1SFA619600R6121	10	0.021
● Yellow	Pulsation	15	60	CB1-612Y	1SFA619600R6123	10	0.021

Rated voltage 230 V AC

● Green	Continuous	55	126	CB1-603G	1SFA619600R6032	10	0.021
● Red	Pulsation	70	60	CB1-613R	1SFA619600R6131	10	0.021
● Yellow	Pulsation	70	60	CB1-613Y	1SFA619600R6133	10	0.021

Non-Illuminated

Color	Sound output	Rated current mA	Luminance mcd	Type	Order code	Pkg qty	Weight (1 pce) kg
-------	--------------	---------------------	------------------	------	------------	---------	----------------------

Rated voltage 24 V AC / DC

● Black	Continuous	40	-	CB1-620B	1SFA619600R6206	10	0.021
	Pulsation	48	-	CB1-630B	1SFA619600R6306	10	0.021

Rated voltage 110 ... 130 V AC

● Black	Continuous	40	-	CB1-621B	1SFA619600R6216	10	0.021
	Pulsation	48	-	CB1-631B	1SFA619600R6316	10	0.021

Rated voltage 110 ... 130 V DC

● Black	Continuous	15	-	CB1-622B	1SFA619600R6226	10	0.021
	Pulsation	15	-	CB1-632B	1SFA619600R6326	10	0.021

Rated voltage 230 V AC

● Black	Continuous	40	-	CB1-623B	1SFA619600R6236	10	0.021
	Pulsation	40	-	CB1-633B	1SFA619600R6336	10	0.021

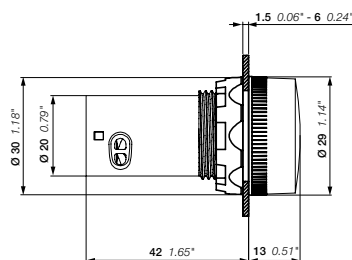

CB1

Dimensions (mm, inches)

Compact range

Accessories



Description	Bezel / color	Type	Order code	Pkg qty	Weight (1pce) kg
30 mm adaptors for 22 mm operator (1.5 - 4 mm panel thickness)					
Emergency stop pushbuttons, MPM	Black plastic	KA1-8027	1SFA616920R8027	1	0.007
	Chrome metal	KA1-8028	1SFA616920R8028	1	0.021
Pushbuttons, selector switches, pilot lights, potentiometers, emergency stop pushbuttons, MPE	Black plastic	KA1-8029	1SFA616920R8029	1	0.010
Flush mounted pushbuttons	Chrome metal	KA1-8073	1SFA616920R8073	1	0.050
Flush mounted selector switches	Chrome metal	MA1-8074	1SFA611920R8074	1	0.050
Protective membrane, silicone					
Flush pushbutton		MA1-8052	1SFA611920R8052	10	0.002
Extended pushbutton		MA1-8002	1SFA611920R8002	10	0.002
Protective ring					
To prevent accidental operation. Cannot be used together with Legend plate holder					
Flush and extended pushbuttons	Clear plastic	-	SK615512-1	10	0.002
Flush pushbuttons	Metal and black plastic	KA1-8010	1SFA616920R8010	10	0.008
Bezel					
Pushbuttons	Black plastic	KA1-8022	1SFA616920R8022	10	0.002
	Chrome plastic	KA1-8020	1SFA616920R8020	10	0.002
	Chrome metal	KA1-8021	1SFA616920R8021	10	0.015
Selector switches	Black plastic	CA1-8077	1SFA619920R8077	10	0.002
	Chrome metal	CA1-8078	1SFA619920R8078	10	0.010
Square bezel					
Black plastic		-	SK616016-2	10	0.001
Lockable shroud					
Pushbuttons, selector switches	Plastic	MA1-8153	1SFA611920R8153	10	0.023
Emergency stop 30 mm	Metal	-	SK615502-D	1	0.080
Touch guard					
Touch guard		MA1-8152	1SFA611920R8152	10	0.023
Shroud with anti rotation tabs, slot for water drainage					
Emergency stop, machine stop 40 mm	● Yellow	CA1-8053	1SFA619920R8053	10	0.016
	● Grey	CA1-8054	1SFA619920R8054	10	0.016
Lamp changing tool					
Lamp changing tool		KA1-8072	1SFA616920R8072	1	0.002

Note: Din-rail adaptor should be used with 2 contact blocks for rear mounting type MCB..B.

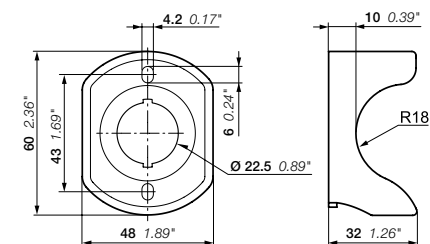

CA1
Dimensions (mm, inches)

Compact range Accessories



CA1-8080

1SFC151276V0001



MA1-8015

1SFC151275V0001



MA1-8149

1SFC151004F0001



MA1-8019

1SFC151385V0001

Description	Bezel / color	Type	Order code	Pkg qty	Weight (1pce) kg
DIN-rail adaptor					
DIN-rail adaptor with 2 dummy block		CA1-8080	1SFA619920R8080	1	0.028
Mounting tools					
For tightening the locking nut					
Plastic / Mounting tool manual		MA1-8015	1SFA611920R8015	1	0.021
Metal / Mounting tool for power tool		MA1-8149	1SFA611920R8149	1	0.155
Extra key					
Key code 455			SK616021-71	10	0.007
Key code 421			SK616021-72	10	0.007
Key code 3433-E			SK616021-73	10	0.007
Locking nut					
Locking nut		MA1-8019	1SFA611920R8019	10	0.001

Compact range

Technical data

Standards and approvals

IEC / EN 60947-1	Low Voltage switchgear and controlgear - Part 1: General rules
IEC / EN 60947-5-1	Low Voltage switchgear and controlgear - part 5-1: control circuit devices and switching elements - Electromechanical control circuit devices
IEC / EN 60947-5-5	Low Voltage switchgear and controlgear - part 5-5: control circuit devices and switching elements - Electrical emergency stop device with mechanical latching function
IEC / EN 60073	Basic and safety principles for man-machine interface, marking and identification coding principles for indicators and actuators
IEC / EN 60529	Degrees of protection provided by enclosures (IP code)
EN 50013	Low Voltage switchgear and controlgear for industrial use, terminal marking and distinctive number for particular control switches
DIN 40050-9	Road vehicles; degrees of protection (IP-code); protection against foreign objects; water and contact; electrical equipment
UL 508	Industrial control equipment
CSA C22.2 No 14	Industrial control equipment

Environmental data

Degrees of protection

Operators	IEC/EN DIN	UL/CSA
Pushbutton	IP66, IP67 and IP69K	Type 1, 3R, 4, 4X, 12, 13
Selector switches	IP66, IP67 and IP69K	Type 1, 3R, 4, 4X, 12, 13
Buzzer	IP66, IP67 and IP69K	Type 1, 3R, 4, 4X, 12, 13
Heavy duty	IP66, IP67 and IP69K	Type 1, 3R, 4, 4X, 12, 13
Pilot lights	IP66, IP67 and IP69K	Type 1, 3R, 4, 4X, 12, 13
Emergency stops	IP66, IP67 and IP69K	Type 1, 3R, 4, 4X, 12, 13
Terminals	IP20	-







Temperature

Ambient temperature during operation	-25 to +70 °C
Storage temperature	-40 to +85 °C











Technical data

Connecting capacity

Compact range M3.0 (pushbutton, selector switch, emergency stop)

	1x 0.5...1.5 mm ²
	2x 0.5...1.5 mm ²
	1x 0.5...1.5 mm ²
	2x 0.5...1.5 mm ²
	1x 0.5...1.5 mm ²
	2x 0.5...1.5 mm ²
	1x 0.5...1.5 mm ²
	2x 0.5...1.5 mm ²
	L < 5.9 mm
	l > 3.0 mm
Stripping length	6.0 mm

Compact range M3.5 (Pilot light)

	1x 0.75...2.5 mm ²
	2x 0.75...2.5 mm ²
	1x 0.75...2.5 mm ²
	2x 0.75...2.5 mm ²
	1x 0.75...2.5 mm ²
	2x 0.75...2.5 mm ²
	1x 0.75...2.5 mm ²
	2x 0.75...2.5 mm ²
	L < 7.0 mm
	l > 3.5 mm
Stripping length	8.0 mm

Tightening torque

Cable terminals M3	0.8 Nm
Cable terminals M3.5	0.9 Nm
Recommended screw-driver for cable terminal	Pozidriv 2
Operators locking nut	Min. 2 Nm / Max. 2.3 Nm

Short circuit protection

Max. fuse at 1 kA	gG 10A
-------------------	--------

Mechanical life

Pushbuttons, selector switches, heavy duty	500 000 operations
Emergency stop pushbutton	50 000 operations

LED products (Pilot lights, illuminated pushbuttons)

Service life for LED means number of service hours until the brightness has been reduced down 50%. Service life 50 000 h, operating at 25 °C, 40~70%rh (relative humidity)

Color of white LED	x = 0.31 Y = 0.32 means the position of color in the ICI chromaticity diagram
Voltage tolerance on LED	-30 to +10% voltage is acceptable without affecting the service life
Voltage peaks on LED	Voltage peaks up to 1000 V current peaks up to 500 mA during a few msec
Glowing light	All integrated LED have a function built in to cut leakage currents
Rated frequency	50/60 Hz for AC supplied products

Make-and-break contacts

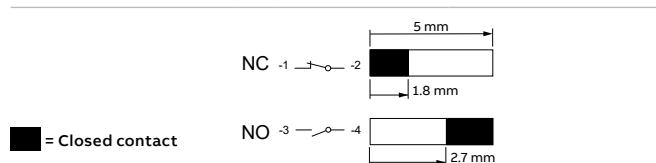

Compact range

Technical data

Material		
No ozone depleting substances in the products.		
All front of panel plastic components are made of polycarbonate		
PC polycarbonate	High impact strength, good outdoor resistance. Chemical resistance (see table below)	
PSU polysulphone	Can withstand high temperatures, acids, basic solutions, alkaline compounds, oils, alcohols	
PA polyamide	Can withstand high temperatures, aliphatic, aromatic and chlorinated hydrocarbons, esters, ketone-aldehydes, alcohols and basic solutions	
PBT	Can withstand high temperature, aliphatic and aromatic hydrocarbons, acids, basic solutions, alcohols, grease and oils	
Zinc	Good corrosion resistance in inland-, sea and industrial atmosphere	
Light-alloy	Good corrosion resistance in inland-, sea and industrial atmosphere	
Chemical resistance for polycarbonate		
Chemical class	Effects	
Acids	No significant effect under most typical conditions of concentration and temperature	
Alcohols and alkalis	Generally compatible at low concentration and room temperature. Higher concentrations and elevated temperatures can result in etching and attack evidenced by decomposition	
Aliphatic hydrocarbons	Generally compatible	
Amines	Surface crystallization and chemical attack	Avoid
Aromatic hydrocarbons	Partial solvents and severe stress cracking agents (i.e., xylene, toluene).	Avoid
Detergents and cleaners	Mild soap solutions are generally compatible. Strong alkaline materials should be avoided	
Esters	Cause severe crystallization. Partial solvents.	Avoid
Greases and oils	Pure petroleum types generally compatible. Many additives used with them are not	
Halogenated, hydrocarbons	Solvents.	Avoid
Ketones	Cause severe crystallization and stress cracking. Partial solvents.	Avoid
Silicone oil and greases	Generally compatible up to 85 °C	

Note: Specified degree of protection is for operator mounted on panel. If other items are mounted in between, please make sure that they are correctly sealed.

Electrical data		
Contacts		
Rated frequency		50-60 Hz
Ratings as per IEC 60947-5-1		
Rated insulation voltage, U_i		300 V
Rated thermal current, I_{th}		5 A
Rated operational current, I_e	at: 240 V	1 A
Utilization category AC 15,		
Rated operational current, I_e	at: 24 V	0.3 A
utilisation category DC 13,	at: 125 V	0.2 A
Rated impulse withstand voltage	U_{imp}	6 kV
Pollution degree		3
Ratings as per UL, CSA, NEMA		
		C300 AC
		R300 DC
Rated insulation voltage		250 V
Rated thermal current		2.5 A
Rated operational current	at: 120 V	1.5 A
	at: 125 V	
	at: 240 V	0.22 A
	at: 250 V	0.11 A
Short circuit protection		
Max. fuse at 1 kA		gG 10A
Buzzer		
Short circuit protection		
Max. fuse at 1 kA		gG 10A
Ratings as per IEC 60947-5-1		
Rated insulation voltage, U_i		300 V
Rated impulse withstand voltage u_{imp}		4 kV
Rated frequency		50-60 Hz
Product service life		> 5000 hours
Signal output		
Sound level		≥ 80 dB /10 cm
Audio frequency		6.7 kHz
Pulsating frequency of light and sound output		2 Hz

Compact range

Technical data

Illuminated pushbuttons CP

Color	Current		Illuminance of flush cap		Illuminance of extended cap		Anti-inductive peak voltage	Main wavelength	Color temperature
	mA Min.	Max.	lx Min.	Max.	lx Min.	Max.			
Voltage range 24 V AC / DC									
● Red	8.5	11.5	150	600	120	400	5	620 ... 625	–
● Green	8.0	11.0	200	800	150	500	5	515 ... 520	–
● Yellow	8.5	11.5	200	800	120	400	5	585 ... 590	–
● Blue	8.5	10.5	200	500	200	400	5	465 ... 470	–
○ Clear	8.5	10.5	620	1000	360	700	5	–	8000 ... 12000
Voltage range 110 ... 130 V AC / DC									
● Red	6.5	9.0	150	600	100	350	15	620 ... 625	–
● Green	6.5	9.0	150	600	100	350	15	515 ... 520	–
● Yellow	6.5	9.0	150	600	100	350	15	585 ... 590	–
● Blue	6.5	9.0	200	450	180	300	15	465 ... 470	–
○ Clear	6.5	9.0	520	860	300	600	15	–	8000 ... 12000
Voltage range 230 V AC / DC									
● Red	4.0	6.0	150	600	120	400	15	620 ... 625	–
● Green	4.0	6.0	150	900	150	500	15	515 ... 520	–
● Yellow	4.0	6.0	150	600	150	500	15	585 ... 590	–
● Blue	4.0	6.0	250	500	250	400	15	465 ... 470	–
○ Clear	4.0	6.0	650	1050	380	720	15	–	8000 ... 12000

Note: The testing distance of illuminance is 2 mm between top lens and sensor surface. Clean test environment, supply voltage at 50 / 60 Hz with harmonized wave and without high frequency.

Compact range

Technical data

Pilot light CL2

Color	Current		Illuminance		Anti-inductive peak voltage V	Main wavelength Nm	Color temperature K
	mA Min.	Max.	lx Min.	Max.			
Voltage range 6.3 V DC							
● Red	13	16	45	250	2	620 ... 625	–
● Green	9.5	12.5	114	245	2	515 ... 520	–
● Yellow	13	16	65	210	2	585 ... 590	–
● Blue	9.5	12.5	8	35	2	465 ... 470	–
○ Clear	10	13	300	850	2	–	8000 ... 12000
Voltage range 12 V DC							
● Red	14	16	100	280	2	620 ... 625	–
● Green	12	14	165	310	2.5	515 ... 520	–
● Yellow	13.5	16	85	230	2.5	585 ... 590	–
● Blue	12	14	10	50	2.5	465 ... 470	–
○ Clear	12.5	14.5	480	850	2.5	–	8000 ... 12000
Voltage range 24 V AC / DC							
● Red	14	16	75	240	6	620 ... 625	–
● Green	13.5	15	120	320	6	515 ... 520	–
● Yellow	14	16	55	230	6	585 ... 590	–
● Blue	13.5	15	8	30	6	465 ... 470	–
○ Clear	13.5	15	450	700	6	–	8000 ... 12000
Voltage range 48 ... 60 V AC / DC							
● Red	14.5	16.5	75	200	7	620 ... 625	–
● Green	14.5	16.5	140	340	7	515 ... 520	–
● Yellow	14.5	16.5	55	330	7	585 ... 590	–
● Blue	14.5	16.5	10	45	7	465 ... 470	–
○ Clear	14.5	16.5	550	800	7	–	8000 ... 12000
Voltage range 110 ... 130 V AC							
● Red	14.5	17	85	340	20	620 ... 625	–
● Green	14.5	17	95	400	20	515 ... 520	–
● Yellow	14.5	17	85	250	20	585 ... 590	–
● Blue	14.5	17	8	30	20	465 ... 470	–
○ Clear	14.5	17	400	700	20	–	8000 ... 12000
Voltage range 110 ... 130 V DC							
● Red	7.5	9.5	40	110	20	620 ... 625	–
● Green	7.5	9.5	80	250	20	515 ... 520	–
● Yellow	7.5	9.5	45	165	20	585 ... 590	–
● Blue	7.5	9.5	6	35	20	465 ... 470	–
○ Clear	7.5	9.5	300	400	20	–	8000 ... 12000

Note: The testing distance of illuminance is 2 mm between top lens and sensor surface. Clean test environment, supply voltage at 50 / 60 Hz with harmonized wave and without high frequency.

Compact range

Technical data

Pilot light CL2

Color	Current		Illuminance		Anti-inductive peak voltage	Main wavelength	Color temperature
	mA Min.	Max.	lx Min.	Max.	V	Nm	K
Voltage range 220 V DC							
● Red	5	6	15	85	20	620 ... 625	–
● Green	5	6	55	180	20	515 ... 520	–
● Yellow	5	6	15	115	20	585 ... 590	–
● Blue	5	6	5	35	20	465 ... 470	–
○ Clear	5	6	200	320	20	–	8000 ... 12000
Voltage range 230 V AC							
● Red	14.5	17	85	340	30	620 ... 625	–
● Green	14.5	17	95	400	35	515 ... 520	–
● Yellow	14.5	17	85	235	35	585 ... 590	–
● Blue	14.5	17	8	30	35	465 ... 470	–
○ Clear	14.5	17	400	700	35	–	8000 ... 12000
Voltage range 380 ... 415 V AC							
● Red	14.5	17	85	340	55	620 ... 625	–
● Green	14.5	17	95	400	65	515 ... 520	–
● Yellow	14.5	17	100	270	65	585 ... 590	–
● Blue	14.5	17	8	30	65	465 ... 470	–
○ Clear	14.5	17	400	700	65	–	8000 ... 12000
Voltage range 230 V AC high anti-inductive voltage							
● Red	14.5	17	55	255	60	620 ... 625	–
● Green	14.5	17	60	265	80	515 ... 520	–
● Yellow	14.5	17	45	210	70	585 ... 590	–
● Blue	14.5	17	5	25	80	465 ... 470	–
○ Clear	14.5	17	280	490	80	–	8000 ... 12000

Note: The testing distance of illuminance is 2 mm between top lens and sensor surface. Clean test environment, supply voltage at 50 / 60 Hz with harmonized wave and without high frequency.

Compact range

Technical data

Buzzer CB

Color	Light and sound output	Current			Illuminance		Sound press level (dB/10cm)
		mA Min.		Max.	lx Min.	Max.	
Voltage range 24 V AC / DC							
● Red	Pulsation	63	75	150	450		≥90
● Yellow	Pulsation	63	75	70	300		≥90
● Green	Continuous	43	53	150	600		≥90
● Black	Pulsation	58	72	–	–		≥90
● Black	Continuous	40	50	–	–		≥90
Voltage range 110 ... 30 V AC							
● Red	Pulsation	71	81	70	300		≥90
● Yellow	Pulsation	72	87	150	450		≥90
● Green	Continuous	50	60	150	600		≥90
● Black	Pulsation	42	54	–	–		≥90
● Black	Continuous	40	50	–	–		≥90
Voltage range 110 ... 130 V DC							
● Red	Pulsation	13	18	5	50		≥80
● Yellow	Pulsation	13	18	5	50		≥80
● Green	Continuous	13	18	15	100		≥80
● Black	Pulsation	13	18	–	–		≥80
● Black	Continuous	13	18	–	–		≥80
Voltage range 230 V AC							
● Red	Pulsation	70	84	150	450		≥90
● Yellow	Pulsation	72	82	70	300		≥90
● Green	Continuous	50	62	350	900		≥90
● Black	Pulsation	42	54	–	–		≥90
● Black	Continuous	43	53	–	–		≥90

Note: The testing distance of illuminance is 2 mm between top lens and sensor surface. Clean test environment, supply voltage at 50 / 60 Hz with harmonized wave and without high frequency.
Fluctuation of rated voltage: -10% to +10%.

Compact range

Drilling plan

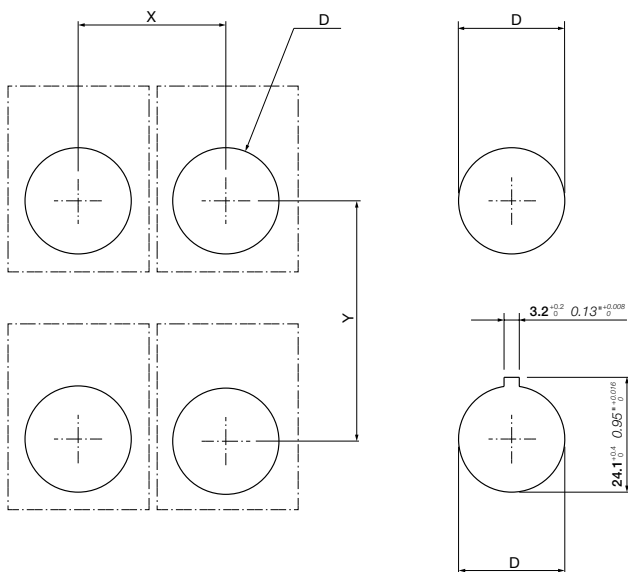

Type	Description	X	Y	D		Panel thickness
				Ø mm	inch	
CP, CL, CSS, CB	Pushbutton, Pilot light, Selector switch, Buzzer	31 1.22"	50 1.97"	$\text{Ø } 22.3^{+0.4}_0$	0.88" $^{+0.016}_0$	1.5 0.06" - 6 0.24"
CP, CL, CSS, CB	Pushbutton, Pilot light, Selector switch, Buzzer (with legend plate)	31 1.22"	55 2.17"	$\text{Ø } 22.3^{+0.4}_0$	0.88" $^{+0.016}_0$	1.5 0.06" - 6 0.24"
CPM, CP6, CE	Mushroom pushbutton, Heavy duty pushbutton	41 1.61"	55 2.17"	$\text{Ø } 22.3^{+0.4}_0$	0.88" $^{+0.016}_0$	1.5 0.06" - 6 0.24"

